

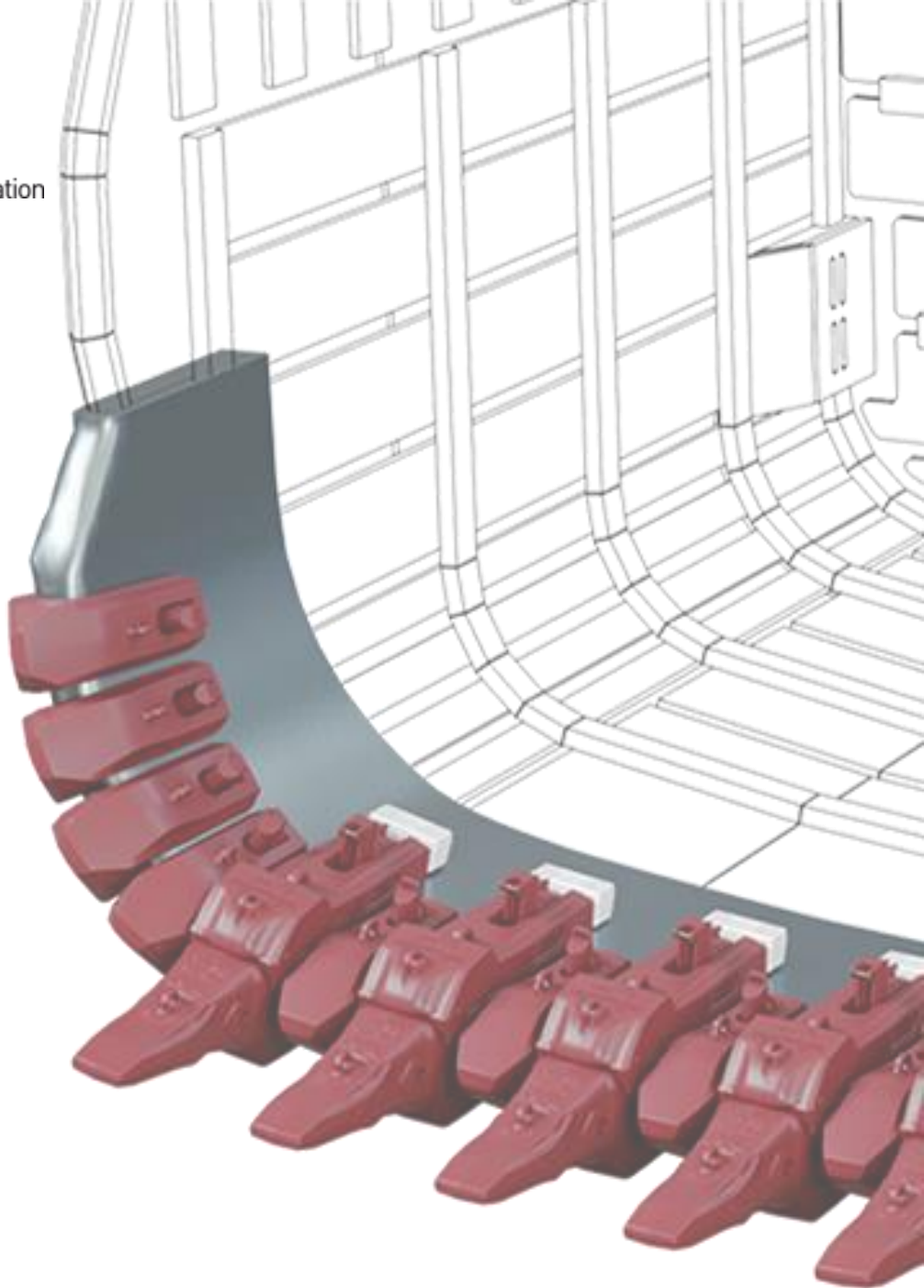

MTG

No limits innovation



INS.3.8.1

Upper Wing Shroud Bevel + Conventional 2-part Locking C2

Installation procedure

DISCLAIMER

© MTG, all rights reserved

The brands identified with an asterisk do not belong to METALOGENIA S.A. and this organization refers to them only to identify the destination of its products, without there being any relationship between METALOGENIA S.A. and the legitimate owners of any such brands.

Copy right: It is strictly forbidden for any person not belonging to MTG to distribute all or any part of the material set out in this document unless they are authorized to do so.

Liability: To ensure the correct use and handling of the MTG products without risk, please carefully read the corresponding service instructions set out on the MTG website. MTG will not be held liable for damages, loss, injury, or death arising from incorrect use or failure to heed the provisions of this guide. Similarly, MTG will not be held liable for damages caused due to the faulty installation or handling of its products. MTG likewise declines all liability for recommendations related to the use or handling of MTG products set out in documents not expressly authorized by MTG.

1. SAFETY

The practices described in this manual can be taken as guidelines for operating safely in many conditions and in addition to the safety standards that are current and enforceable in your area or region.

Your safety and the safety of third parties is the result of putting into practice your knowledge of the correct operational procedures.

Attention, when performing the work described in these instructions, always work safely and use the personal protection elements required to minimize or avoid injury. Always wear:



To avoid eye injury, always wear safety goggles or a protective mask when using any equipment, hammer or similar tool. When equipment is under pressure or when objects are struck, chips or other debris can be thrown out. Make sure no one gets hurt by the debris that is fired before applying pressure or hitting an object. Wear eye protection that complies with ANSI Z87.1 and OSHA standards. Also wear hearing protection and gloves.

Lifting a heavy object can cause serious or fatal injury. DO NOT exceed the maximum rated capacity of lifting and positioning devices: Stay away from the area under a suspended load.



LIFTING LUG

Make sure that the chain is not damaged and that the load is always balanced.

2. WING SHROUD INSTALLATION

CAUTION: Installation of MTG products may require reconstructive work on the lip, such as welding and grinding, to return it to its original geometry and ensure proper fit and performance.



To perform the reconstruction/recalibration of lips, it is mandatory to follow the MTG reparation instructions for rope shovels which describe the proper procedures for recovering the lip geometry by using MTG gauges. Please contact technical.services@mtg.es for further information.

- 2.1** Mount the wing shroud onto its station ensuring contact between the wing shroud and the dipper wing. Keep in mind that **there are both left and right versions of the wing shrouds and that each wing shroud requires two locking mechanisms.**

DIPPER SIDE VIEW

DIPPER FRONT VIEW

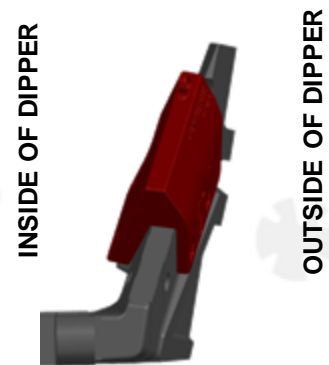
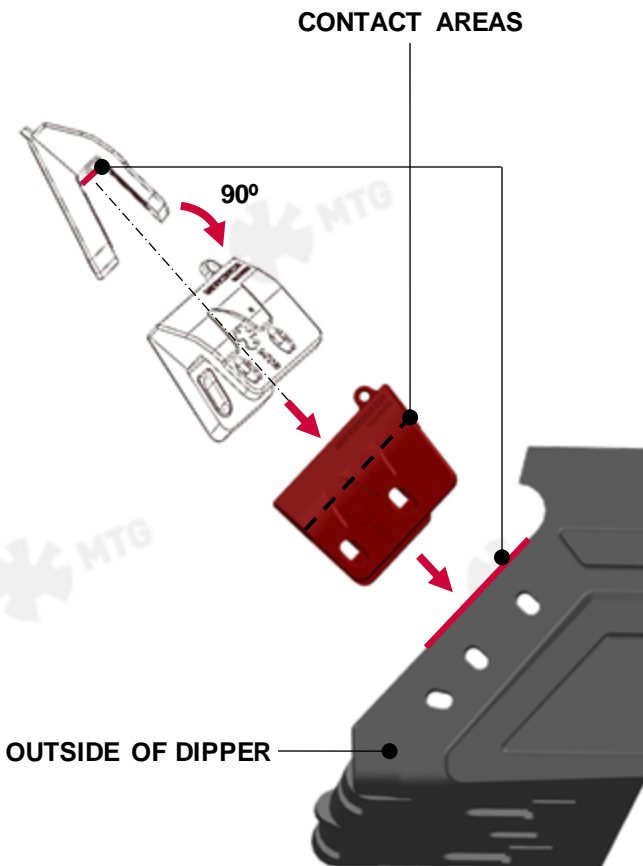

DIPPER TOP VIEW

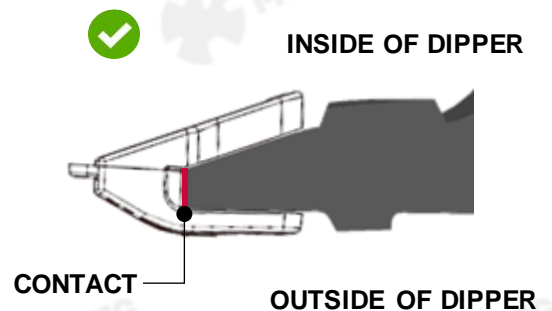

2.2 Use the handle on the C-Clamp to install it from **the inside of the dipper**.

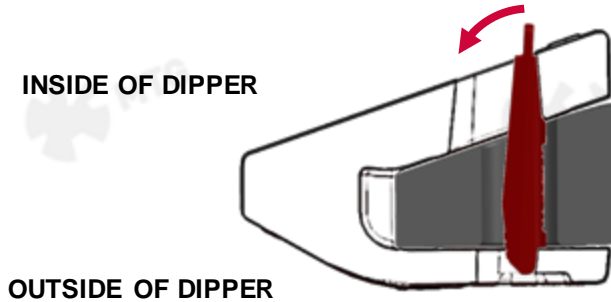

2.3 Align and insert the wedge from the inside of the dipper. Strike the wedge in with a heavy hammer (>10 kg [>25 lb]) until the wedge can no longer enter. The wedge should extend above the wing shroud between 63.5 and 88.5 mm [2.5 and 3.5 inches].

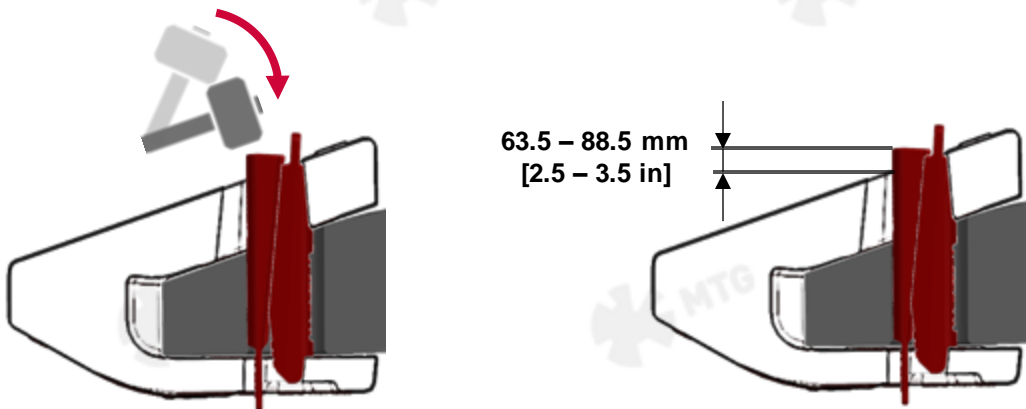

2.4 Once installed, heat the tongue at the end of the wedge with a torch and hammer it back towards the C-Clamp so that it is hidden within the housing.

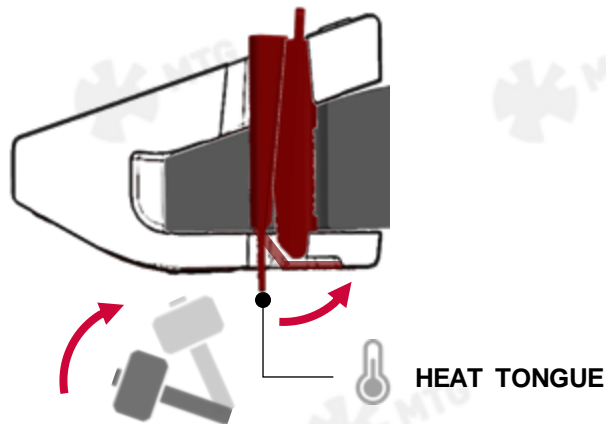

2.5 Repeat steps 2.2 through 2.4 to install the second locking mechanism.

3. WING SHROUD REMOVAL

3.1 Place the dipper in a safe position to access the wedge from the outside of the dipper.



3.2 If it is still in place, cut the tongue at the end of the wedge flush with the shroud using a torch. Place an extractor bar on the bottom surface of the wedge and strike it out with a heavy hammer (>10 kg [>25 lb]). The wedge will fall into the dipper.

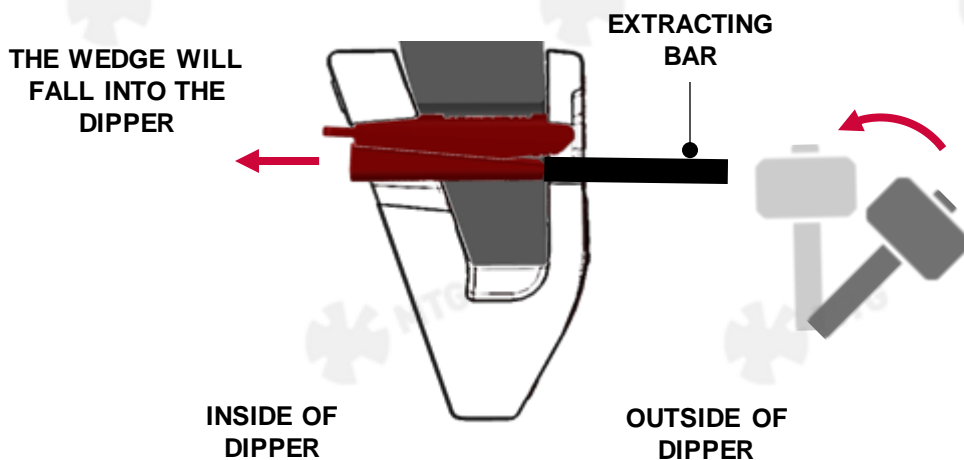

3.3 Extract the C-Clamp.

3.4 Repeat steps 3.2 and 3.3 to remove the second locking mechanism. The wing shroud will no longer be locked and may now be removed.



Service Instructions

The latest welding recommendations and assembly / disassembly instructions can be found online:

www.mtgcorp.com/manuals

Please contact Technical Services in case of questions:

technical.services@mtg.es



MTG HEADQUARTERS

Carrer d'Àvila, 45
08005 Barcelona (Spain)
(+34) 93 741 70 00
info@mtg.es

MTG NORTH AMERICA

4740 Consulate Plaza Drive
Houston, TX 77032 (USA)
+1 (281) 872 1500
info@mtgcorp.us

MTG AUSTRALIA

16 – 18 Thorpe Close
Welshpool, WA, 6106 (AUS)
+61 8 6248 6513
Info.australia@mtg.es